

## QUICK START GUIDE

### Automate™ Crestron Home

#### INTEGRATION SUPPORT



#### AUTOMATE PULSE PRO OVERVIEW

Elevate your Automate experience by seamlessly integrating Automate motorized shades into Crestron Home Integration systems. The Automate Pulse PRO offers a powerful integration with discrete shade control and two-way communication, providing real-time updates on shade position and battery levels. Featuring both Ethernet (CAT 5) and 2.4GHz wireless connectivity, the Pulse PRO ensures smooth home automation integration through an easy-to-access RJ45 port located on the back of the hub. Each hub supports up to 30 shades, making it a versatile solution for any home automation setup.

#### OVERVIEW:

The Pulse PRO driver provides Total Control users with two-way control of their shades, using a two-way IP driver control status feedback of Pulse PRO hubs and connected shades which is in the Crestron Home database. Before integrating Pulse PRO shades into the Crestron System, users must first configure their Pulse PRO Hub and shades. This process is done entirely in the Automate Shades Android or iOS app.

#### CRESTRON HOME COMPATIBILITY:

The Crestron Home with Automate Pulse PRO two-way module is compatible with Accelerator 3 and Flex 2 software platforms.

#### REQUIREMENTS:

An installed and functional Pulse PRO shade system using:

- An Automate Pulse PRO Hub is configured and functioning properly.
- Windows shades installed and configured with the Pulse PRO Hub.

#### HARDWARE INSTALLATION:

- Install all shades/blinds/motors at desired locations.
- Connect the Hub to the Automate Pulse app on the same network as the Crestron Home System.
- Connect all shades/blinds/motors to the Automate Shades app.

#### MODULE FEATURES:

- Two-way control of shades
- Custom macro integration
- Queries
- Device Events
- All Shades supported by Pulse PRO Hub.
- Auto discovery process

#### DRIVER

- Initial Release
- This release note is for the Rollease Automate Pulse PRO Gateway IP Crestron Home driver.
- Notes and Recommendations
- This driver is compatible on Crestron Home processors using Crestron Home v3.007.0166.
- System Requirements and Dependencies
- Minimum version requirements:

#### 4-SERIES:

- Processor firmware 2.4508.00085
- Crestron Home v3.007.0166
- Crestron Home SDK 8.0000.0012

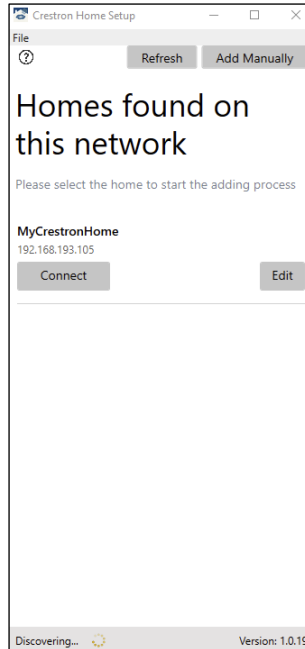
#### WORKS WITH:

- CP4-R
- MC4-R

## INSTALLATION INSTRUCTIONS:

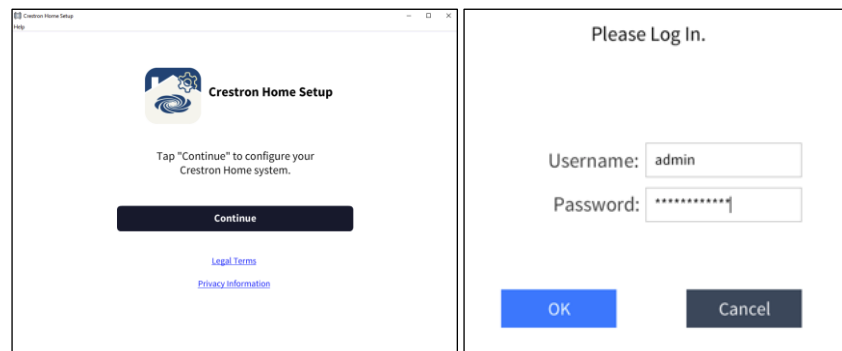
Follow the steps below to load and configure the driver.

1. Open the Crestron Home Setup App (either mobile version or desktop version) and connect to the Crestron Home control processor.



**Figure 1:** Connect to the Crestron Home processor.

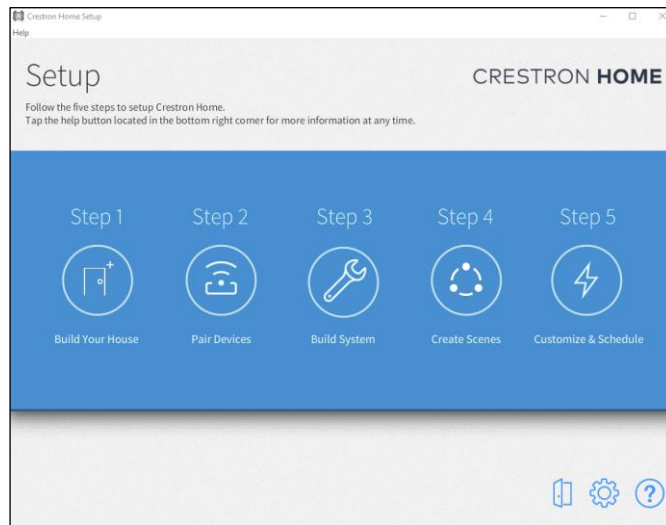
2. When the setup app opens, press **Continue** on the main screen and log in with the Crestron Home administrator credentials.



**Figure 2:** Log in into the Crestron Home System

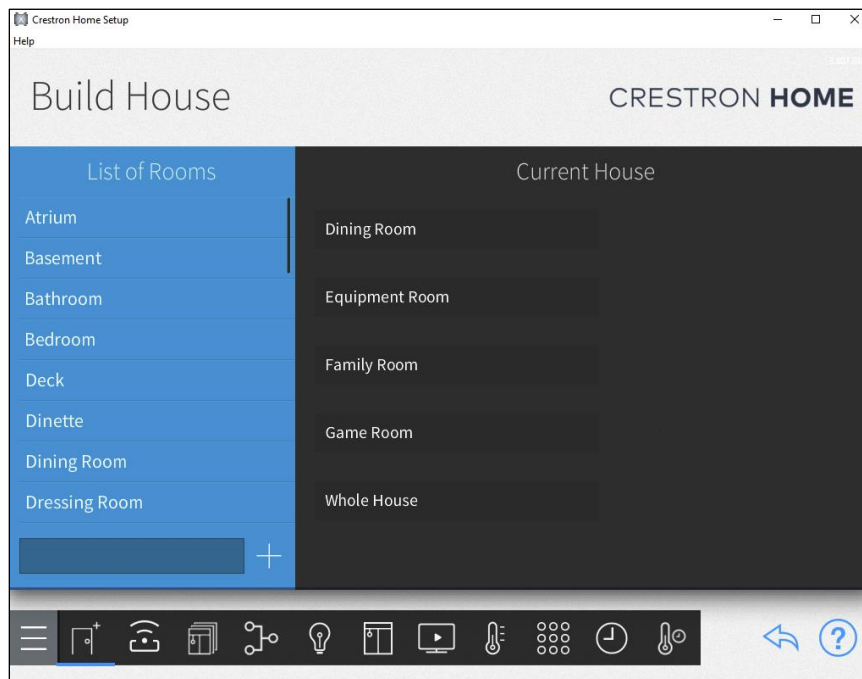
# AUTOMATE™

Once logged in, the Setup page will be displayed.



**Figure 3:** Start the setup process following the steps on the Crestron Home System

3. If setting up Crestron Home for the first time, press on **Build Your House** to add rooms to your configuration, otherwise skip to step 5 below.

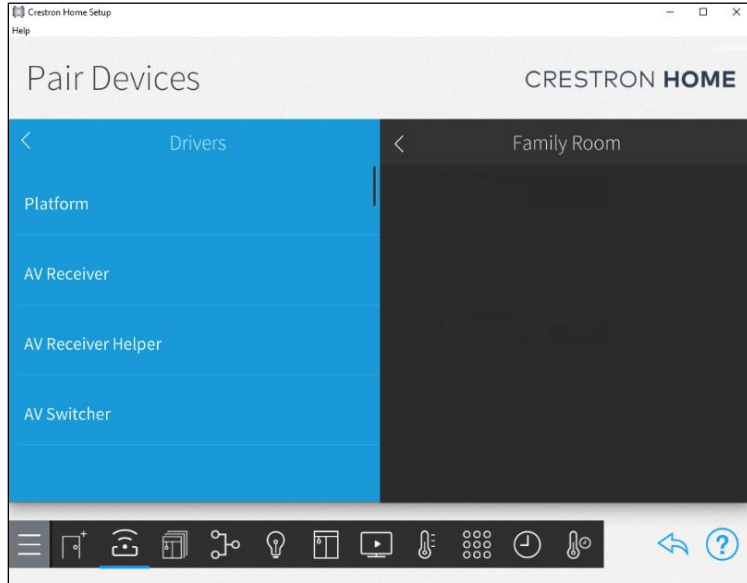


**Figure 4:** Build your Home if this is your first configuration.

4. Scroll through the list of available rooms and press the **Plus Sign (+)** to add the room to your configuration. A custom room name can be added by typing in the name field next to the **Plus Sign**.



5. From the Setup page, press **Pair Devices** or press the Pair Devices Icon

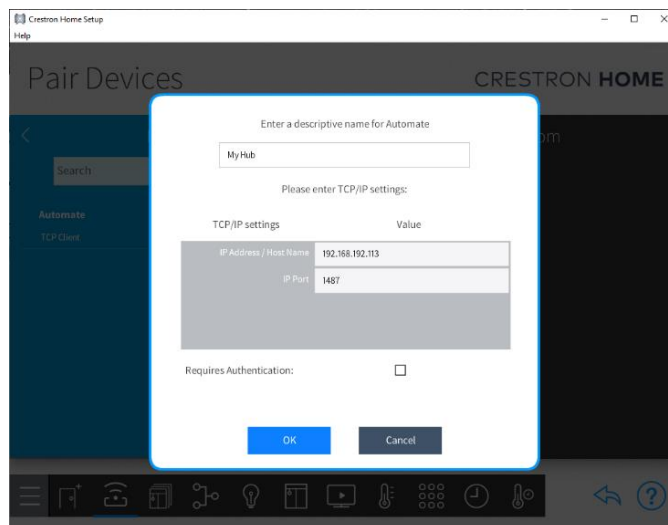


**Figure 5:** Pair New Devices (Pulse PRO Hub) with Crestron Home.

6. Follow the instructions in steps 6-13 if adding a driver for the first time, otherwise skip to step 14. In the **Pair Devices** screen, select the room to which the driver will be added from the right side of the screen, then select **Drivers** from the menu options on the left side of the screen.
7. Scroll to the driver type, press the **Platform** driver type name.
8. Scroll to the **Automate** make (manufacturer).



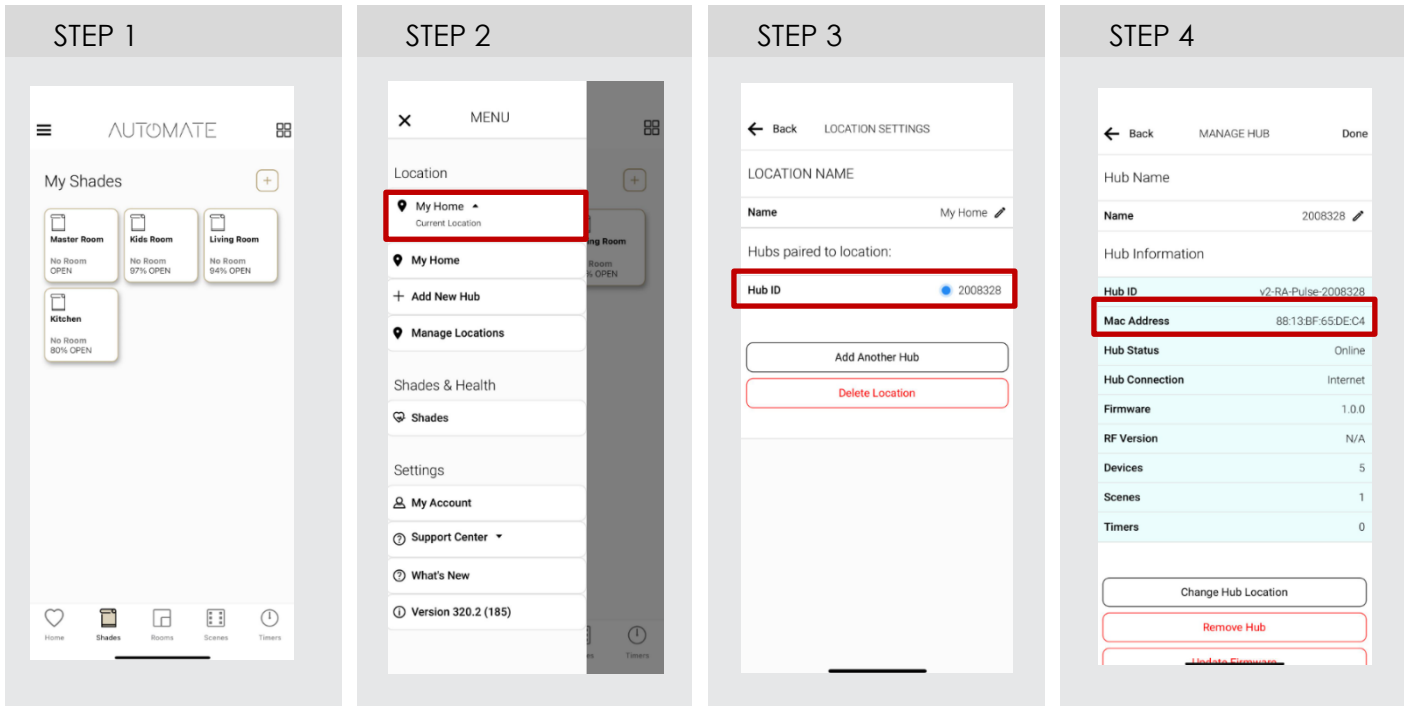
9. Press the **Plus Sign (+)** to add the gateway client to the project.
10. Enter the friendly name for the driver and the IP address to connect to.



**Figure 6:** Add the Pulse PRO Hub IP address on Crestron Home System

# AUTOMATE™

10.1 Follow below the steps to get the MAC address from the Pulse PRO App using the device configuration screen.



11. Press **OK** and the gateway will be added to the selected room. At this point, the gateway will go out and discover all of the motors and a folder of found paired devices will appear in the menu above the TCP Client driver. The name of the folder will reflect the name given to the gateway driver in the previous step.

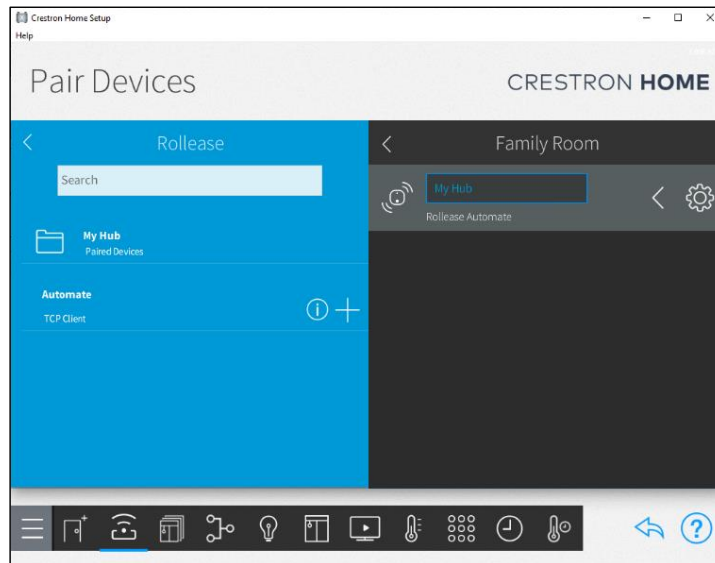
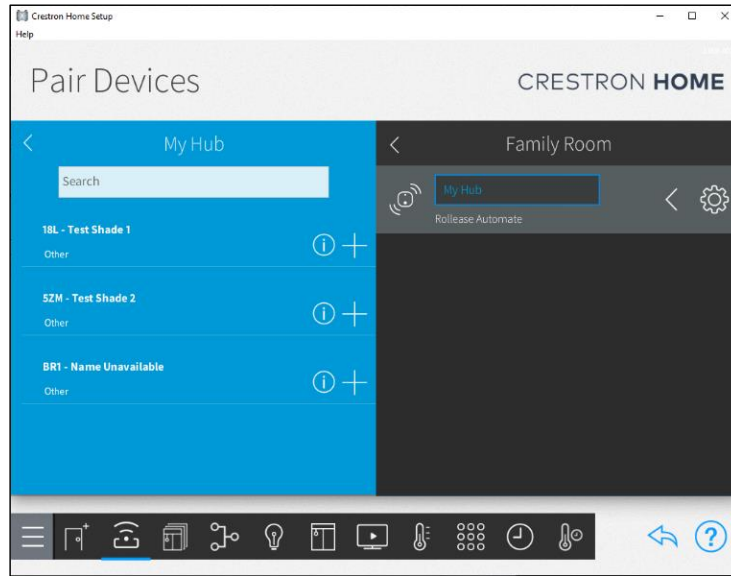


Figure 7: Pulse PRO Hub will auto-discover all the shades paired with Pulse PRO App

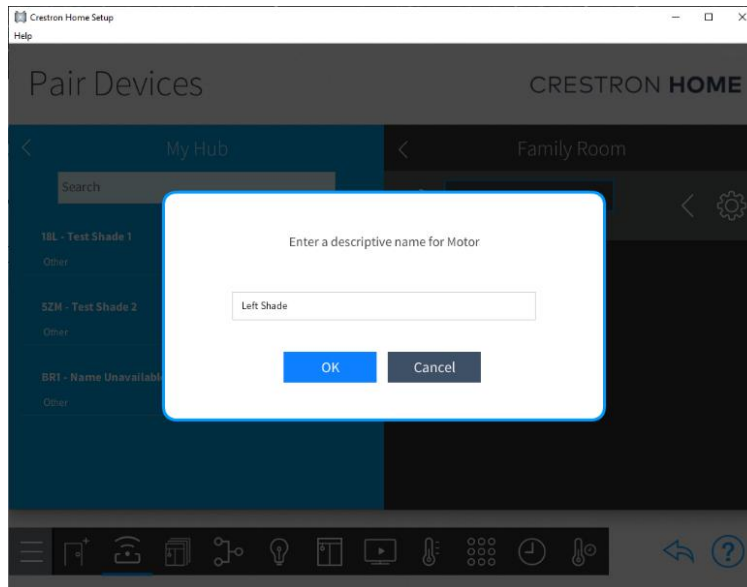
# AUTOMATE™

12. Press the **Paired Devices** folder to see the discovered motors.




**Figure 8:** All the shades discovered by Crestron Home.

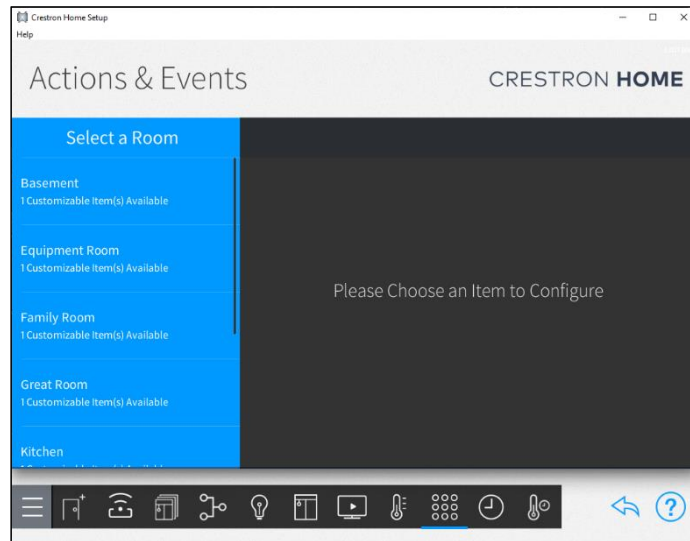
13. Add device drivers to their corresponding rooms by selecting a room on the right side of the screen, then press the **Plus Sign (+)** next to the driver to add to the selected room. Enter a friendly name for each driver as they are added. Note that as each device is added to a room, it is removed from the folder of detected devices.



**Figure 9:** Name the individual shades as you desire. If you prefer to keep the same name as on the Automate Shades App.

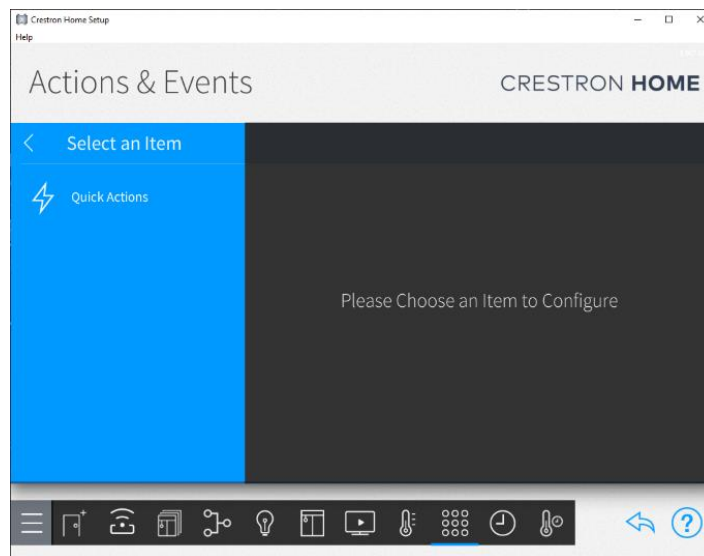
When all devices are added, the folder of paired devices is removed. If a device is removed from a room, it will reappear in the paired devices folder and be available to add to a different room.

14. Press the **Actions & Events** button  from the bottom menu bar to navigate to the **Quick Actions** page.
15. Select a room to add quick actions to.

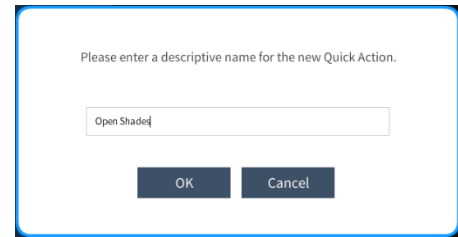
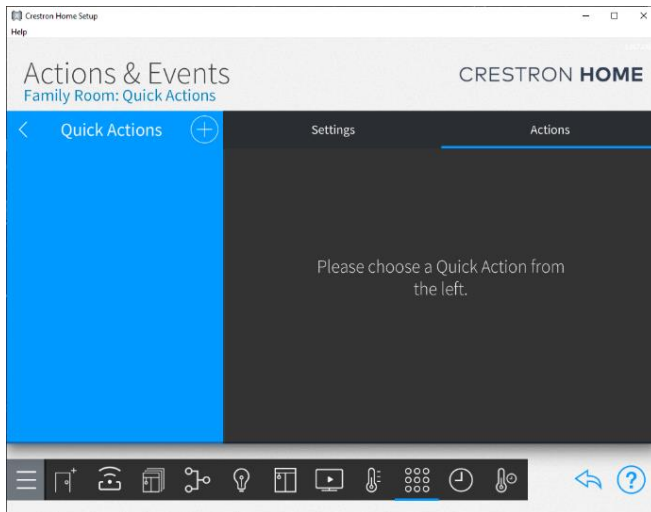


**Figure 10:** Create Quick Actions as scenes and timers into your Crestron Home.

16. Press the **Quick Actions** menu item to navigate to the **Actions & Events** page for the room you selected.

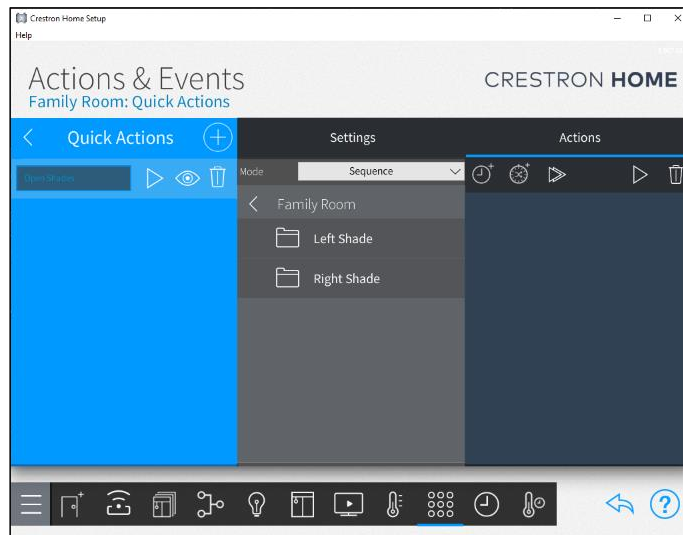


- Press the **Plus Sign (+)** next to **Quick Actions** to add a quick action and add a name for the quick action.



**Figure 11:** Name the Action on the System to control a group of shades.

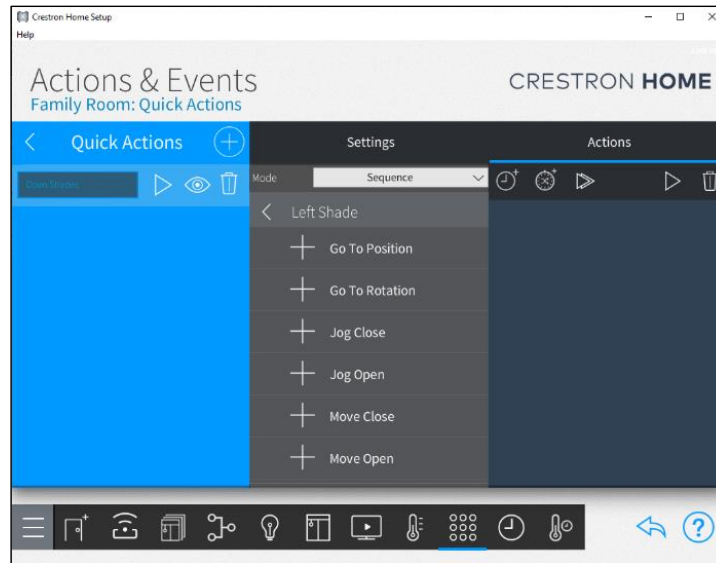
- Select **Sequence** from the **Mode** drop-down menu, then select the room to add the quick action to.




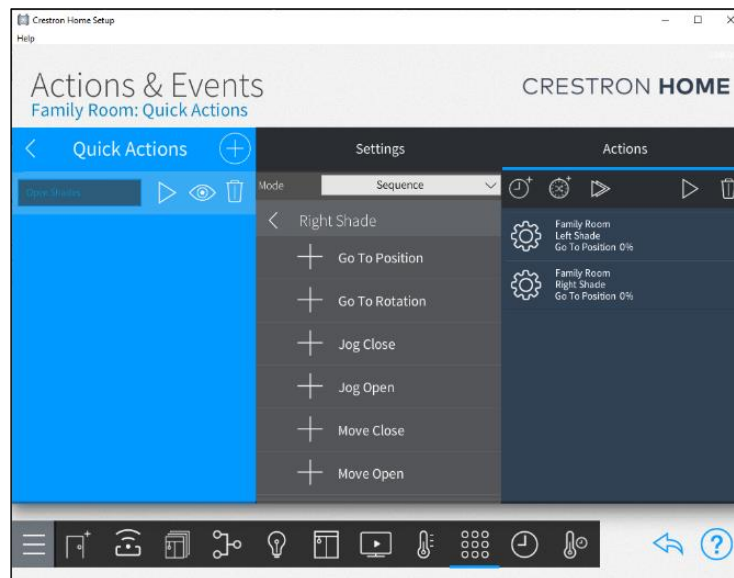
- Press the name of the device driver, such as **Left Shade**.



# AUTOMATE™

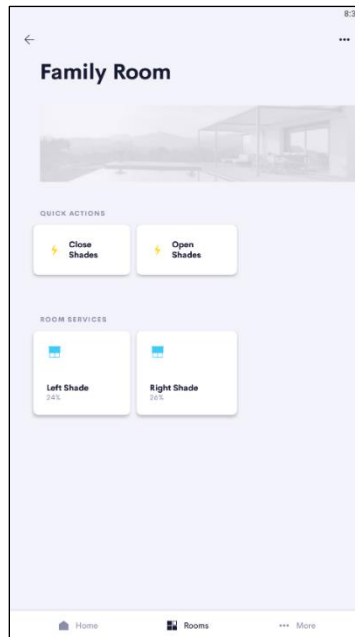


20. Press the **Plus Sign (+)** sign next to the function this quick action will trigger. Observe that the custom feature is added to the sequence of actions. More than one function can be added to the quick action sequence. To remove a function, press the trash can icon  in the Actions menu and press the function to remove.



**Quick Actions Displayed:**

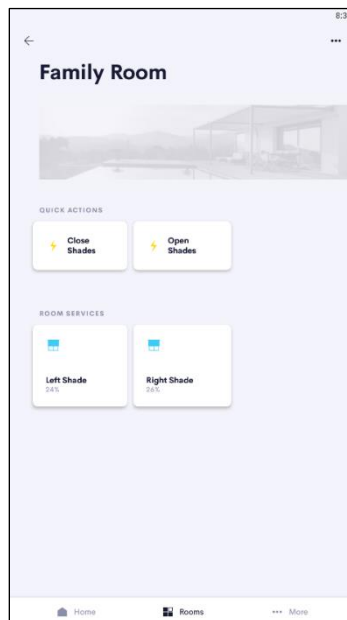
Quick actions will appear in the Crestron Home User App when the room to which the quick actions have been added is displayed.



**Figure 12:** User Experience Interface for individual and group control.

### End-User Experience:

The screenshot below shows an example of a room page where a device driver has been added. The room page shows any Quick Actions added to the room for the driver.

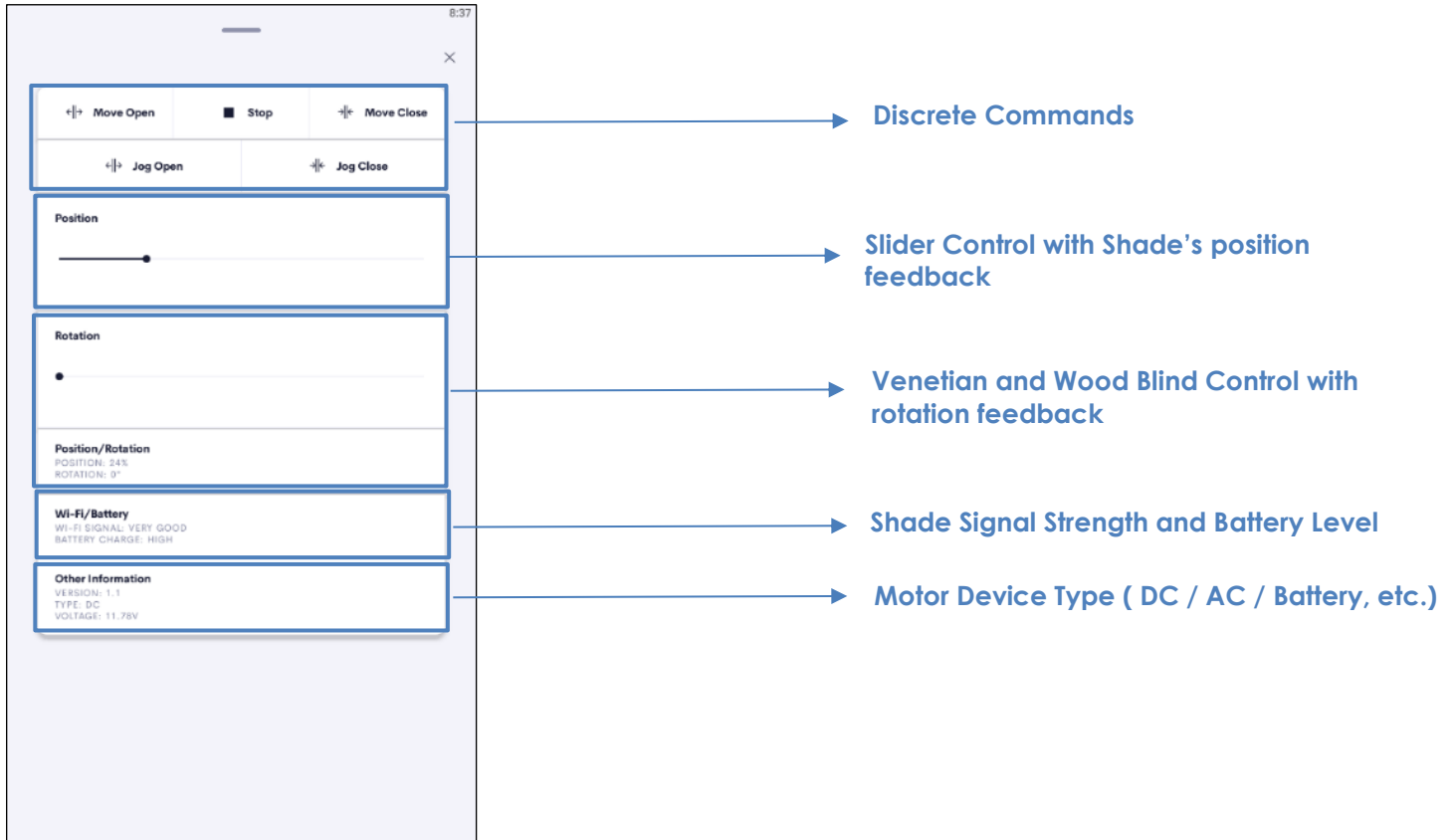


The screenshot below shows the shade device control added to the Family Room. This screenshot shows the controls available for

# AUTOMATE™

the shade.

Due to the ARC Bidirectional communication, all the shade information can be shown in on the Crestron Home Device Control as per below:



## Limitations/Known Issues:

The Rollease Automate Pulse PRO Gateway IP driver is only compatible with Crestron Home.

**It is not compatible with:** AV Framework or SIMPL Windows.

## Supported Features:

The gateway driver has no user-accessible features. The motor driver includes the following features:

### Control

- Move Open
- Move Close
- Move Stop
- Jog Open
- Jog Close
- Go to Position
- Go to Rotation

### Feedback

- Current Position
- Current Rotation
- Wi-Fi Signal Level
- Battery Charge Level
- Firmware Version
- Charge Type
- Voltage

## Test Systems Environment:

# AUTOMATE™

The test environment for the driver is as follows:

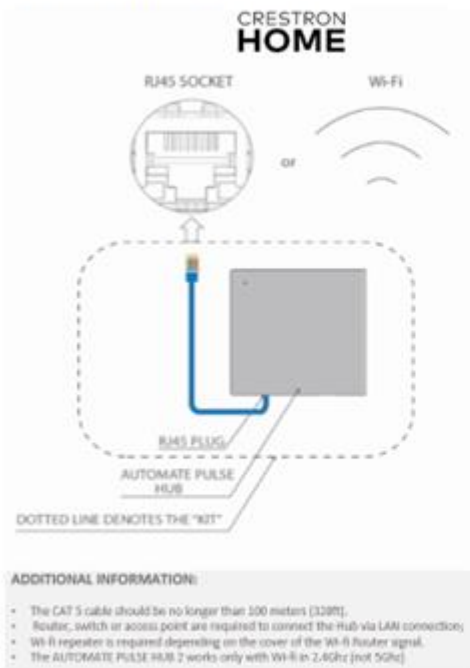
- Crestron CP4-R v2.45.08.0085
- Crestron Home v3.007.0166
- Crestron Home App v 1.12.17

## **Rollease Supported Models:**

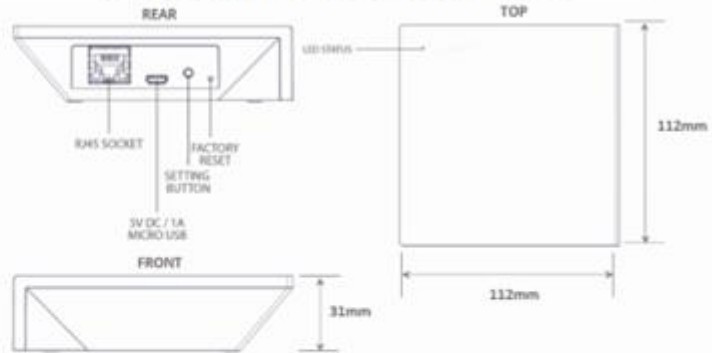
The Rollease Automate Pulse PRO Gateway is the only model gateway this driver supports. All motors that can be added to the Rollease Automate Pulse PRO hub are also supported.

# AUTOMATE™

## INTEGRATION TOPOLOGY

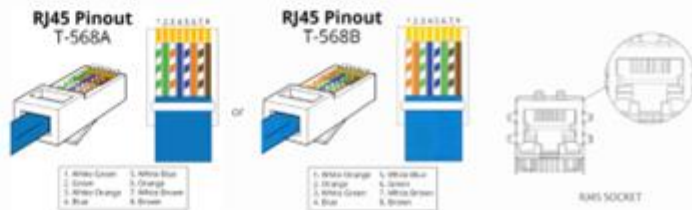


## AUTOMATE PULSE PRO HUB



## CONNECTIONS

The standard connections of the Automate Pulse Hub 2 is Ethernet or Wi-Fi. For a LAN connection, you can use a straight Through wiring accordingly indicated below:



## FREQUENTLY ASKED QUESTIONS

### Q. No Pulse PRO Hub detected.

A. Make sure that your Automate Pulse PRO is connected to the correct network and get an IP Address available and still communicating with the network using the Automate Shades App.

### Q. Shade limits are not set properly.

A. Calibrate shade limits with your Rollease Acmeda remote before setting the appropriate open and close time within Crestron Home SYSTEM.

### Q. Shade is not moving at all.

A. Make sure the selected Pulse PRO Hub is the correct Pulse PRO Hub for the shade to be controlled. Confirm the correct bindings are set in the Crestron Home System connections tab between the Pulse PRO Hub and Shade drivers.

### Q. I have multiple Pulse PRO Hubs, what do I do?

A. Load two Automate Pulse PRO Hub drivers. After selecting "Retrieve Hubs" located in the driver actions tab, you will see different Automate Pulse PRO Hubs - select the desired one.

### Q. I do not see any shade bindings in the Pulse PRO Hub driver?

A. Select "Retrieve Shades" located in the driver actions tab.

### Q. How do I scan for available Automate Pulse PRO Hub?

A. Once the Automate Pulse PRO Hub is properly connected via the Ethernet cable or Wireless network, navigate to the Automate Pulse PRO Hub Properties page within Composer. Select "Retrieve Hubs" located in the driver actions tab.

### Q. We get unexpected responses from the Crestron Home system, or "?" symbols.

A. Ensure that all connections using the ethernet port or Wi-Fi are working properly. The missed connection has been known to yield unwanted or unexpected results.

## SUPPORT RESOURCES:

For further assistance, contact your retailer, visit our website at [www.automateshades.com](http://www.automateshades.com).