



Basic Remote 5ch

Programming Guide

MT02-0101-069011_v1.3_16022024

SAFETY

Incorrect installation or use can lead to serious injury and will void manufacturer's liability and warranty. It is important for the safety of persons to follow the enclosed instructions.

Save these instructions for future reference.



WARNING: Do not ingest battery, Chemical Burn Hazard.

- Do not expose to water, moisture, humid and damp environments or extreme temperatures.
- Persons (including children) with reduced physical, sensory or mental capabilities, or lack of experience and knowledge, should not be allowed to use this product.
- Use or modification outside the scope of this instruction manual will void warranty.
- Installation and programming to be performed by a suitably qualified installer.
- Follow installation instructions.
- For use with motorized shading devices.
- Frequently inspect for improper operation.
- Do not use if repair or adjustment is necessary.
- Keep clear when in operation.
- Replace battery with correctly specified type.

This product contains a coin/button cell battery. If the coin/button cell battery is swallowed, it can cause severe internal burns in just 2 hours and can lead to death.

Keep new and used batteries away from children. If the battery compartment does not close securely, stop using the product and keep it away from children.

If you think batteries might have been swallowed or placed inside any part of the body, seek immediate medical attention.



Do not dispose of in general waste.



FCC & ICED STATEMENT

This device complies with part 15 of the FCC Rules. Operation is subject to the following two conditions:

- (1) This device may not cause harmful interference, and
- (2) this device must accept any interference received, including interference that may cause undesired operation.

Caution: Changes or modifications to this unit not expressly approved by the party responsible for compliance could void the user's authority to operate the equipment.

This device contains licence-exempt transmitter(s)/ receiver(s) that comply with Innovation, Science and Economic Development Canada's licence-exempt RSS(s). Operation is subject to the following two conditions:

- (1) This device may not cause interference.
- (2) This device must accept any interference, including interference that may cause undesired operation of the device.

L'émetteur/récepteur exempt de licence contenu dans le présent appareil est conforme aux CNR d'Innovation, Sciences et Développement économique Canada applicables aux appareils radio exempts de licence. L'exploitation est autorisée aux deux conditions suivantes :

- 1) L'appareil ne doit pas produire de brouillage;
- 2) L'appareil doit accepter tout brouillage radioélectrique subi, même si le brouillage est susceptible d'en compromettre le fonctionnement.

NOTE: This equipment has been tested and found to comply with the limits for a Class B digital device, pursuant to part 15 of the FCC Rules. These limits are designed to provide reasonable protection against harmful interference in a residential installation. This equipment generates, uses and can radiate radio frequency energy and, if not installed and used in accordance with the instructions, may cause harmful interference to radio communications. However, there is no guarantee that interference will not occur in a particular installation. If this equipment does cause harmful interference to radio or television reception, which can be determined by turning the equipment off and on, the user is encouraged to try to correct the interference by one or more of the following measures:

1. ASSEMBLY

Please refer to separate Rollease Acmeda System Assembly Manual for full assembly instructions relevant to the hardware system being used.

2. BATTERY MANAGEMENT

For battery motors; Prevent discharging the battery completely for extended periods, recharge as soon as the battery is discharged.

CHARGING NOTES
Charge your motor for 6-8hours, depending on the motor model, as per motor instructions.



During operation, if battery is low, the LED in motor will flicker 8 times to give a low-voltage alarm when motor starts.

P1 LOCATION AND MOTOR HEAD FUNCTIONS

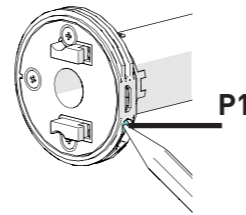

BUTTON OVERVIEW

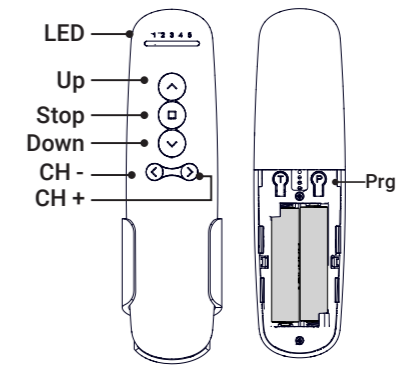

REPLACE BATTERY

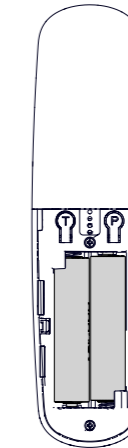

WALL MOUNTING

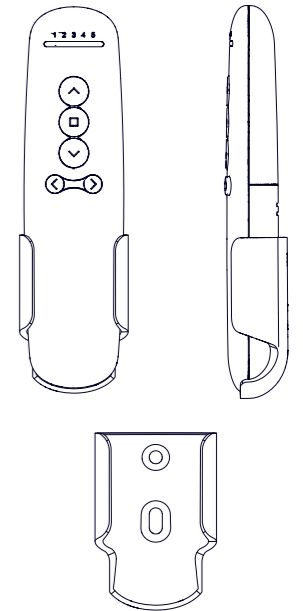

REMOTE CONTROL PARAMETERS

Electrical Specification	Standard
Battery Type	AAA battery*2
Working Temperature	-10°C-50°C
Radio Frequency	433.92M±100KHz
Transmit Distance	>=30m indoor

INSTALLER

INSTALLER

This setup wizard should be used for new installation or factory reset motors only. Individual steps may not work if you haven't followed the setup from the beginning.

Pairing with Remote

STEP 1.
Select the desired channel you wish to program by scrolling using the arrows on the remote control

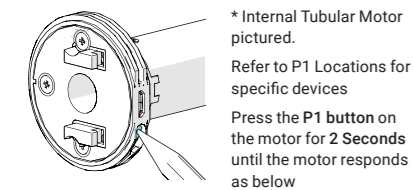

MOTOR RESPONSE



Within 4 seconds hold the stop button on the remote for 3 seconds.



MOTOR RESPONSE



Check direction

STEP 2.
Press up or down to check the motor direction. If correct skip to step 4.

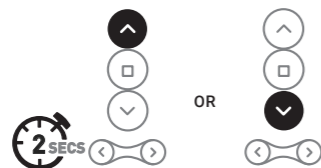

Change direction

STEP 3.
If the shade direction needs to be reversed: press and hold the up & down arrow together for 2 sec until the motor Jogs



MOTOR RESPONSE



If limits are set: press Prg on controller-->JOGx1-->press UP-->JOGx1-->press DOWN-->JOGx1

Set top limit

STEP 4.

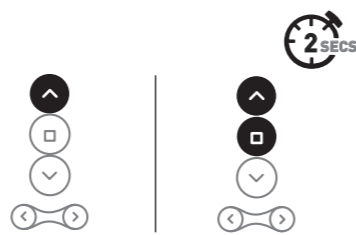

Move shade to desired top limit by pressing the up arrow repeatedly. Then press and hold up & stop together for 2 sec to save limit.

Tap the arrow several times or hold down if needed; press arrow to stop.

MOTOR RESPONSE



Set Bottom limit

STEP 5.

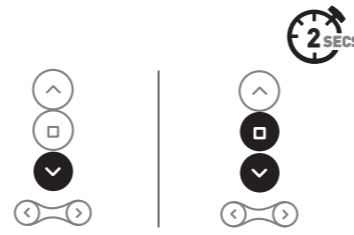

Move shade to desired bottom limit by pressing the down arrow repeatedly. Then press and hold down & stop together for 2 sec to save limit.

Tap the arrow several times or hold down if needed; press arrow to stop.

MOTOR RESPONSE



MOTOR RESET PROCEDURE Factory reset

To reset all settings in the motor press and hold the P1 Button for 14 seconds, you should see 4 independent jogs followed.

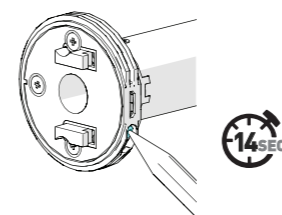

* Internal Tubular Motor pictured above.
Refer to "P1 Locations" for specific devices

MOTOR RESPONSE



Remove or add remote

Using the P1 button, press and hold the button for 2S. The motors will JOG x1. Then, hold the STOP about 2S on remote to add or remove. The motor will respond with JOG x2 to add remote, the motor will respond with JOG x1 to remove remote.

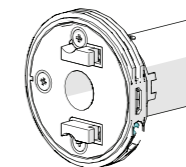

MOTOR RESPONSE



Remove or add remote

Using a pre-existing Remote: press the Prg button on existing remote, shade will respond with JOGx1. Then, press Prg button on existing remote, and the shade will respond with JOGx1. Finally, press STOP on new controller to add the remote and the shade will JOGx2, press STOP on new controller to remove the remote and the shade will JOGx1.

Existing Remote New Remote

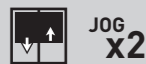
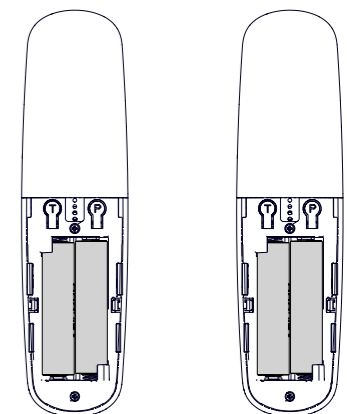

Set favorite position

Move shade to the desired position by pressing the UP or Down button on the Remote. After that , press and Hold CH-> and STOP buttons together on the remote for about 2S. Shade will JOGx2

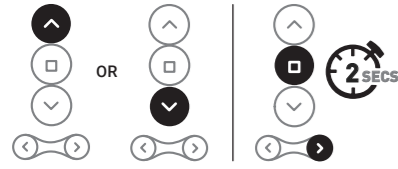

MOTOR RESPONSE

Send Shade to favorite position

To move the shade to the the Favorite position, Hold STOP on remote for 2S

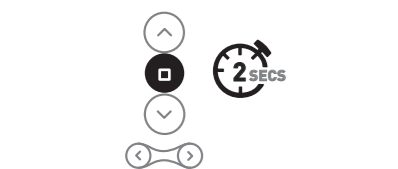

Entering in tilt mode

Press Prg button on Remote and shade will JOGx1. Then, press STOP, shade will JOGx1, and press STOP and the shade will JOGx1 once again.

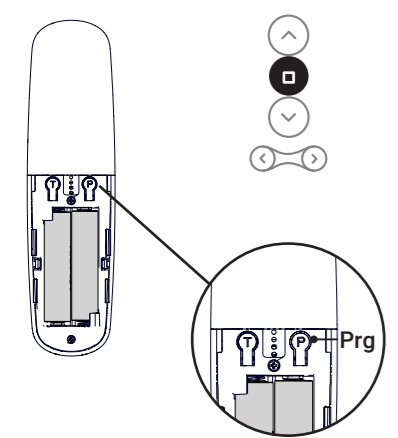

MOTOR RESPONSE

Same operation can toggle from tilt mode to constant -touch mode.
 Note: When motor in tilt mode, hold UP or DOWN on controller for more than 2s, it will run in constant-touch mode.

Delete favorite position

To Delete the favorite position, Press and Hold CH-> and STOP together on the remote for about 2S. Shade will JOGx1

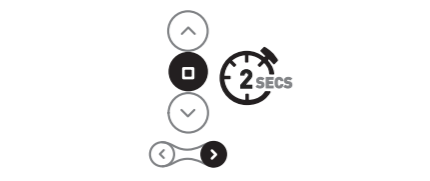

MOTOR RESPONSE

Change Motor speed

To Increase motor speed: Press the Prg button on Remote. Shade will JOGx1, Then, press the STOP button, shade will JOGx1, press UP button once and shade will JOGx1 again.

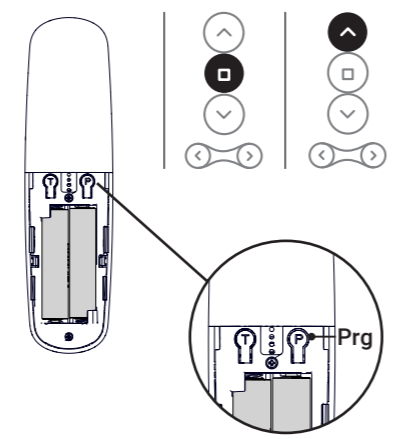

MOTOR RESPONSE

Change Motor speed

To decrease motor speed: Press the Prg button on Remote. Shade will JOGx1, Then, press the STOP button, shade will JOGx1, press Down button once and shade will JOGx1 again.

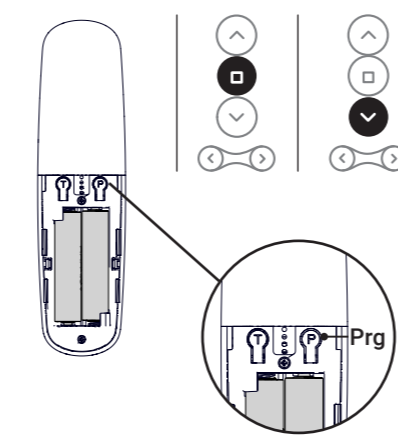

MOTOR RESPONSE

Note: If motor doesn't jog, the max/min speed has already been reached. JOGx1

Adjust the limits

To Adjust upper limit, press and hold both UP and STOP for about 5S. Shade will JOGx1. Then, press UP button to save upper limit, hold UP and STOP 2S and the shade will JOGx2

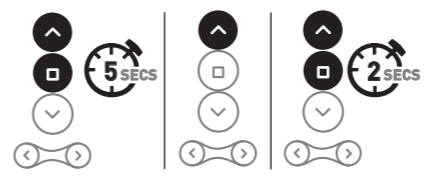

MOTOR RESPONSE

Adjust the limits

To Adjust lower limit, press and hold both DOWN and STOP for about 5S. Shade will JOGx1. Then, press DOWN button to save lower limit, hold DOWN and STOP 2S and the shade will JOGx2



MOTOR RESPONSE

Canceling the limits

Press the Prg button on Remote, shade will JOGx1 Then, press STOP on remote and the shade will JOGx1 again. Finally, press Prg on remote and shade will JOGx1 once again to canceling the limits

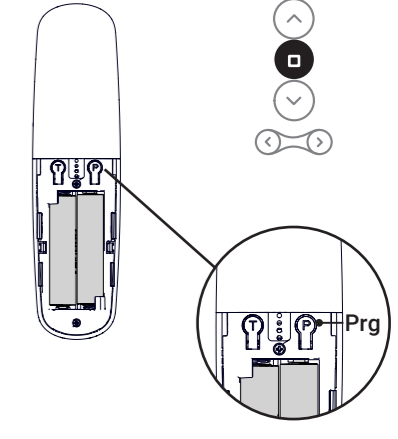

MOTOR RESPONSE

Battery Check

Move shade to desired top limit by pressing and hold the up arrow. Then press and hold up for 5 sec then shade will move to the percentage of the the battery charge remains.

MOTOR RESPONSE